

Wear of coatings in wool-severing applications

R. H. MAIR

Department of Materials Engineering, Monash University, Clayton 3168, Australia

C. C. BERNDT*

Department of Materials Science and Engineering, State University of New York at Stony Brook, Stony Brook, NY 11794, USA

Various surface treatments; including thermally sprayed ceramic coatings, titanium nitride (TiN) deposited by physical vapour deposition and nitrogen implantation processes, have been applied to combs and cutters that are used for wool severance. A series of laboratory and field tests have been carried out to evaluate the relative merits of the different treatments.

1. Introduction

Harvesting of wool from sheep is one of the most labour-intensive parts of the wool industry. It is important that harvesting methods and equipment are continually evaluated to optimize efficiency and working conditions. One aspect that has been considered in recent years is the improvement of equipment used in the shearing of sheep. This includes research and development of the shearing process, finding alternative methods, improving the present equipment to incorporate recent developments in materials engineering and research into automated shearing by robots. It is the second of these, the development and application of new materials, that the present work addresses; though there are elements that could be used in the robotic shearing programme.

A major problem is the relatively low wear resistance of the cutting components used in the shearing handpiece, especially in the Australian environment. These components consist of a reciprocating toothed cutter and a stationary comb which are typically made from high carbon steels that have a limiting hardness of about 68R_c. The steel is toughened by back-tempering to about 60R_c. The phase structure is martensitic with some cementite as the load-bearing component of the microstructure.

Smith and Hindle [1] summarized the methods used to increase the wear life of sheep shears. The techniques include using case-hardened steels, tool steels, sintered tool steels, sintered tungsten carbide and metallic coatings. The problem could also be approached by using different combinations of steels for cutters and combs. This would not only be expensive but would also be limited by the material properties (especially the hardness and toughness) of the steels. Thus improvements of this nature would only give marginal gains in component life; whereas life gains of several hundred times are desired. Other workers [2] have trialed coatings of tungsten carbide and cobalt composites (WC-Co) produced by detonation-gun thermal spraying. These experimental coat-

ings exhibited some promise but the results could never be reproduced. Other surface modifications of the present components are also possible.

It is necessary to refurbish the untreated combs and cutters after shearing about 3-10 sheep. The current objective is to achieve component lifetimes that are equivalent to at least 500 sheep. There are two important equipment adjustments that influence the hand-piece operation [3, 4]. The first is that the comb and cutter are dressed by each shearer according to individual preferences. The second is that the contact force between the comb and cutter can be adjusted by a tension nut. An increase in this force improves the shearing action; however, this also increases the wear rate of the components and operator fatigue.

2. Experimental procedure

2.1. Materials

The coatings that were tested are listed in Table I. A series of laboratory and field tests were performed. Figures of merit were ascertained by measuring the performance of the test components with reference to uncoated components. All experiments were carried out using standard high-carbon steel cutters (0.95% C) with treated and untreated combs.

2.2. Laboratory test rig

Combs and cutters have been tested under as near field conditions as possible. An experimental rig using industrial shearing equipment and handpieces was used, Fig. 1. The force on the cutter was applied using a dead weight lever and pulley system which maintained a constant 200 N, although it can be noted that the contact force, in practice, can reach 350 N when the tension nut is wound down on to worn combs and cutters [5, 6]. The handpiece was driven by a 640 W motor and the cutter/comb reciprocating frequency was 54 Hz.

*Author to whom all correspondence should be addressed.

The prime wear mode was abrasion due to particulate matter, mainly silica, that becomes entrapped in the fleece of the sheep. This wear condition was simulated by passing a mixture of grit and sheep grease (obtained from fleece), carried in a light mineral oil (SAE 30), between the comb and cutter at 20°C. This facilitated rapid tests in a controlled environment.

The surfaces of the combs and cutters were examined by SEM, profilometry and roughness measurements. The features of the as-received materials were compared with those of the components after testing for periods of up to 10 min.

2.3. Severance tests

A multiple fibre test simulated the usual conditions under which the handpiece was used. A 7 cm x 7 cm square of high-loft wool carpet (known as "flokati") substituted for the fleece. The test sample was fixed to a sliding table mounted beneath the shearing handpiece (Fig. 1). A linear displacement transducer attached to the sliding table recorded the time taken by the shears to cut through the length of the test sample; thus giving a semi-quantitative measure of shearing

performance. The diameter of the test fibre was about 30–40 μm , which is much coarser than the 20 μm fibre diameter of merino fleece. The fleece analogue mentioned above is an extension of the accepted single-fibre test method.

2.4. Testing procedure

The components were tested by operating for 10 min under the accelerated conditions of the simulated gritty shearing environment. It was ascertained from a baseline measurement that a 10 min operation corresponded to shearing about 10 sheep with the conventional uncoated components. The severance ability of the comb and cutter was tested at the end of the 10 min run by measuring the time to shear the wool sample. This time corresponds to a measure of the shearing efficiency of the tool. The above tests were then repeated until the severing ability of the test components was lost.

Samples of TiN-coated combs and cutters were also supplied to professional shearers for trials. Their comments about the practical application and "feel" of the coated components were invaluable.

TABLE I Coatings used for shearing test evaluation

Nitrogen-ion implanted components
Tungsten carbide-cobalt applied by the Jet Kote process
Reactive sputtering to deposit titanium nitride

3. Results

3.1. As-received (uncoated) components

A well-worn uncoated comb which had been used for shearing sheep was examined in the SEM. This exhibited damage of the comb edge which was characteristic of abrasion by particulate matter (Fig. 2). An

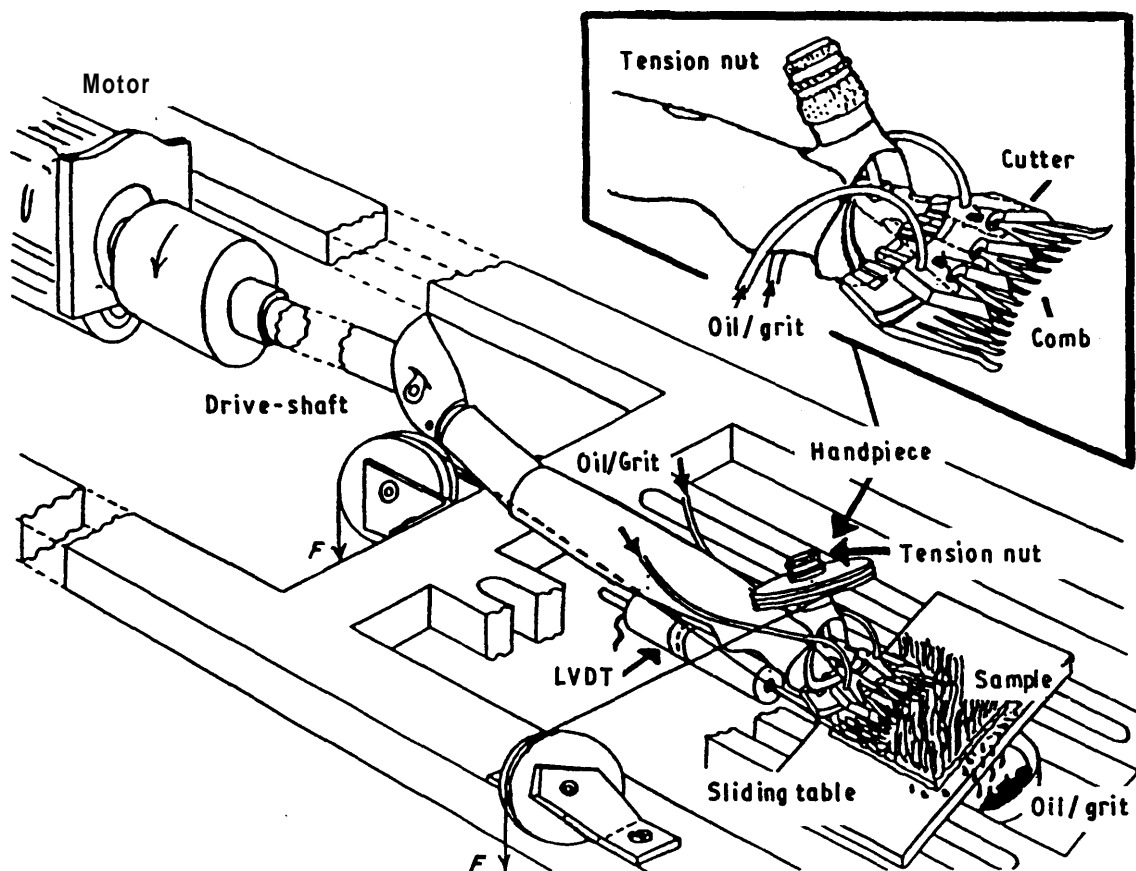

Figure 1 Test rig used for accelerated testing of shearing components.

unused comb and cutter were also examined. They were then run in the shearing test rig, with grit, for 1, 6 and 7.5 min. The combs were inspected for damage after each period. After 7.5 min the comb edges began to round off, with severe damage similar to that seen

on the used comb (Fig. 3a). The cutter edges exhibited brittle fracture and spalling (characteristic of delamination) at the tips (Fig. 3b) due to fretting.

3.2. TiN-coated components

A TiN ($4\mu\text{m}$ thick) coated comb was tested against an uncoated cutter and good self-sharpening attributes were exhibited. Thus the cutter, of hardness $820H_v$, was preferentially worn by the comb which was $2200H_v$; and this presents continually renewed severing edges. It was found that the cutter required a 2 min running-in period to conform to the shape of the TiN-coated surface; though later trials showed that this could be reduced to 30 s.

SEM examination showed that the integrity of the TiN surface before testing was good and exhibited no signs of cracking (Fig. 4a). The surface of the comb remained in good condition. Small cracks appeared in the coating after testing for more than 1 h; however, they did not form a continuous linked network and therefore no chipping was observed. These features arise from surface defects such as grinding marks which are centres of localized stress concentration. The damage to the comb edges was less than that seen on the uncoated comb. Surface profile measurements along the cutter teeth showed that the wear pattern

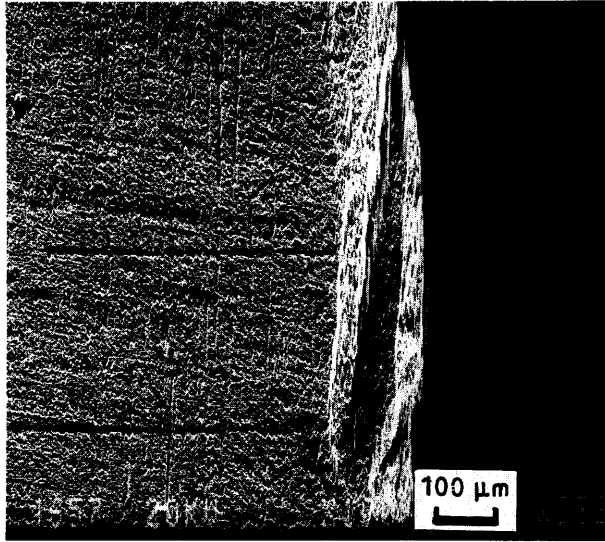

Figure 2 Edge of comb tooth damaged by particulate material.

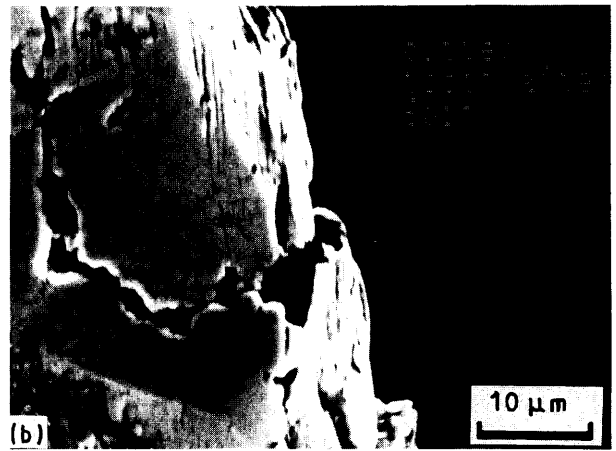

Figure 3 (a) Damage to uncoated comb after 7.5 min testing. (b) Damage to cutter after 6 min testing.

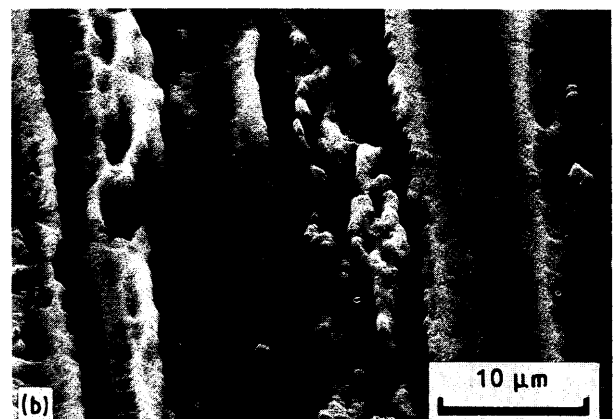
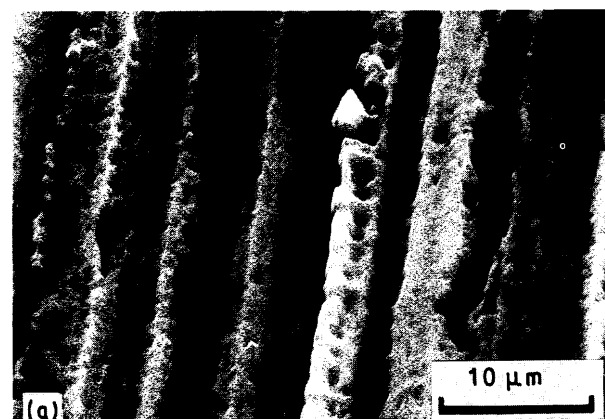

Figure 4 Surface of TiN-coated comb: (a) unused; (b) after being used in a field trial on 100 sheep.

was similar to a cutter used in field trials with a TiN comb (Fig. 4b).

A wear pattern could be observed (Fig. 5a) on the sliding surface of the cutter after 10 min running time in the shearing test rig. Surface roughness data from components measured before and after shearing wear tests are shown in Table II. In all cases the cutter was not coated. Fig. 5a shows the surface morphology

features of the coated and uncoated cutters. The lower cutter was used in a 10 min laboratory test, whereas the upper cutter was used in a field trial on 33 sheep. The same features were observed on both of these cutters and indicates that the accelerated laboratory tests replicates the field conditions that these components experience.

3.3. Tungsten carbide – cobalt-coated components

Two methods of WC-Co deposition were used; these being high velocity oxygen fuel (HVOF) and fuel air repetitive explosion (FARE) gun thermal spraying. The HVOF coating was WC-17 wt % Co and the FARE gun coating was WC-12 wt % Co. The thickness of both coatings was approximately 25 μm . Surface examination showed that these coatings were coarser than the TiN surface, a result confirmed by the surface roughness measurements shown in Table II. The HVOF coating exhibited rounding of the comb edges (Fig. 6) after 10 min wear testing. There was some damage on the FARE gun samples, but this was not as marked as that on the HVOF coatings (Fig. 7).

3.4. Ion-implanted combs

These combs were heat treated by annealing at 900 °C for 2 h and surface ground prior to implantation.

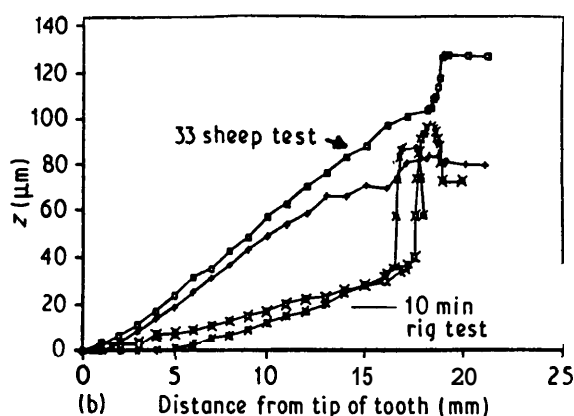
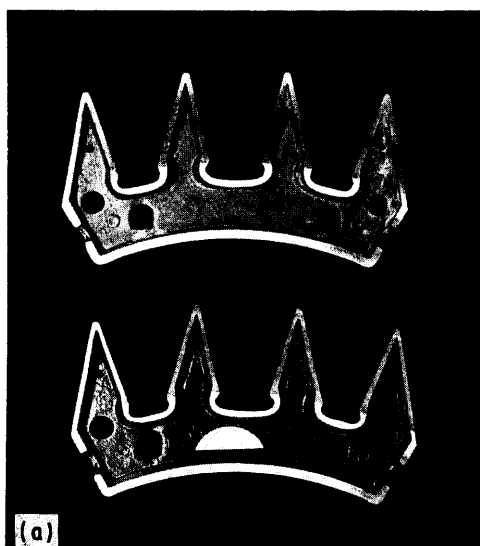

Figure 5 (a) Wear pattern on uncoated cutters with TiN-coated combs. The cutters were used in either a field trial (upper cutter) or a laboratory test (lower cutter) and exhibit similar wear morphologies. (b) Comparison of wear profile along (\diamond , \square) inner and ($+$, $*$) outer edges of a middle tooth of each cutter.

TABLE II Surface roughness measurements for combs and cutters^a

	Time (min) ^b	Coating		
		TiN R_a (μm) ^c	WC-12 Co R_a (μm)	WC-17 Co R_a (μm)
Comb	0	1.21	3.59	3.52
Cutter	0	0.94	1.05	0.82
Cutter	10	0.52	0.75	1.18

^a All cutters were in the as-received (uncoated) condition.

^b 0 min refers to unworn components, 10 min is equivalent to shearing 33 sheep with a TiN-coated comb.

^c R_a is the arithmetic mean of the departures of the roughness profile from the mean.

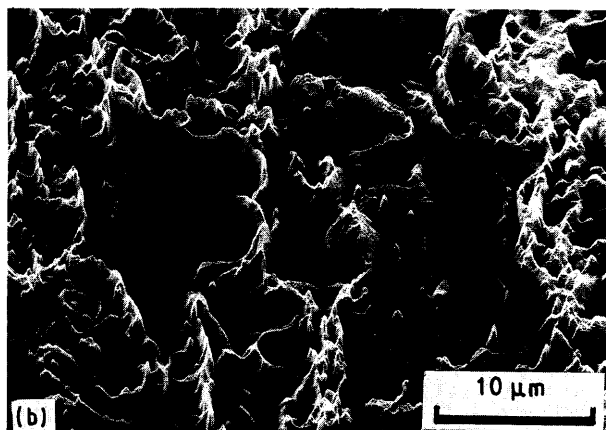
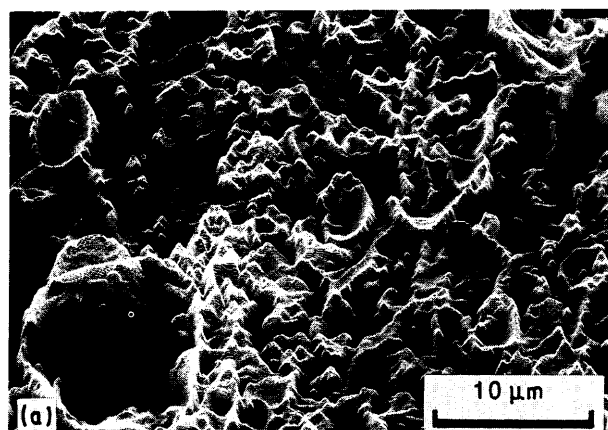

Figure 6 Surface of WC-17% Co HVOF comb: (a) unused; (b) after 10 min wear test.

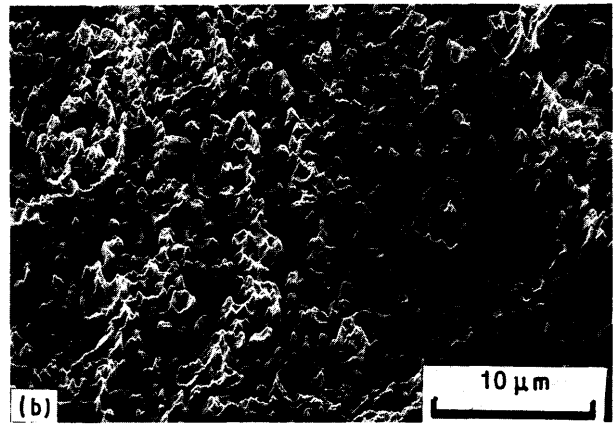
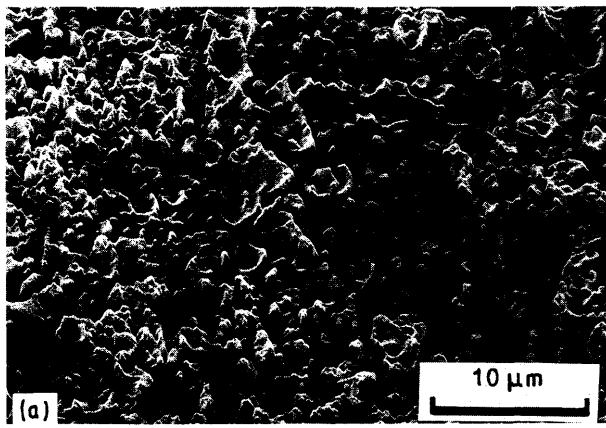

Figure 7 Surface of WC-12% Co FARE gun comb: (a) unused; (b) after 10 min wear test.

The components were distorted during the high-temperature surface modification and the optimum severing mechanics of the shearing components were not retained.

The hardness of these coatings was measured to be between 1200 and 1500 H_v and the diffusion depth is 0.5 mm. These surface-modified materials could not be adequately tested due to their distortion; however, they may be suitable as a coating for the cutter that is self-sharpened by TiN-coated combs. The present studies show that the TiN-coated cutter may be used on a distorted ion-implanted comb.

3.5. Field trials

The TiN coatings were used in field trials. The comb successfully sheared 100 merino sheep with medium wool of 22–24 μm diameter fibre. The cutter was changed three times instead of the usual 10 to 12 times and this is an improvement by a factor of four over the number of cutters normally used under these conditions. It was also reported that the cutters were sharper after use.

Wear patterns on these cutters showed similar features to those tested in the laboratory (Fig. 5a). The cutters were removed from service due to the formation of a step at the rear of the cutting surface. This change in the cutter profile caused wear so that the tip was not cutting. This particular wear pattern results from interaction of the cutter with the groove which is machined in the comb, Fig. 8. SEM examination showed that surface cracks were less than 1% of the total area. These features of the wear process will be discussed later with respect to the wear mechanism.

The WC-Co-coated combs were not field-tested. Previous field trials on D-gun WC-Co-coated combs [2] showed promise, but the high drag associated with the rough surface increased operator fatigue. The D-gun process also caused thermal distortion of the comb which interfered with the cutting geometry.

4. Discussion

4.1. Influence of surface smoothness

One major problem aggravated by the use of coatings

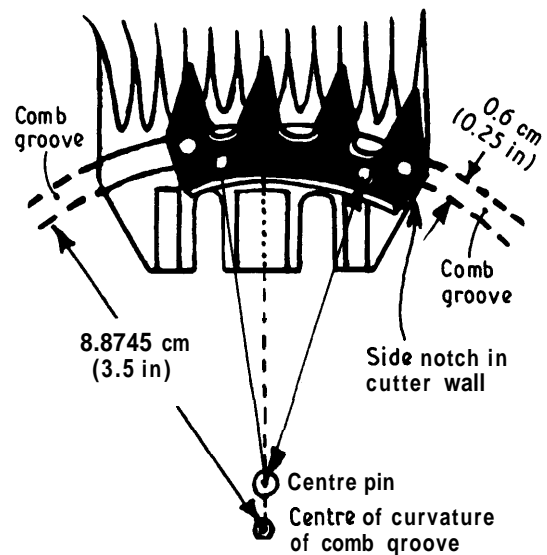

Figure 8 Cutter path followed with respect to the comb geometry.

is drag. The main contributions to drag are undercomb friction, tip penetration, sliding friction and pinching (or trapping) drag [5, 7]. Undercomb friction constitutes 20%–25% of the total drag and arises from friction between the comb and the sheep skin. This drag is not considered in the present work.

The remaining 75%–80% is collectively referred to as cutting drag. Penetration drag is the resistance to the comb tips entering the wool. Sliding friction arises as the wool fibres are forced apart and slide along the prongs of the comb, and trapping drag occurs when the cutter traps fibres against the comb prongs and tensions them immediately prior to severance. The trapping and sliding friction components of drag constitute about 60% of the total drag. They may be minimized by preparing the edges of the comb prongs and comb surface in a smooth condition. Table II indicates that the TiN comb has the smoothest surface of the combs examined. It can be noted that the thicker WC-Co coatings, in common with all as-received thermally sprayed coatings, are more rough and therefore likely to exhibit a high drag and be more susceptible to edge damage than the TiN coating.

Another deficiency of thermally sprayed coatings is that their microstructure is determined by the dimensions of individual "splats". Typically these are 70 μm diameter and 2–5 μm thick; which is much larger than the very fine structures of PVD applied coatings. Thus it is technically difficult, and not common, to produce very thin (less than about 10 pm) thermal spray deposits and any delamination of these coatings has the potential of complete coating removal. PVD deposits do not have these disadvantages.

4.2. Mechanism of failure for wool severance

The wear modes found on the cutter and comb are abrasive in nature. Fretting wear occurs between the tip of the cutter and the comb when a small sliding amplitude causes resonance at the comb tips. Adhesive wear should be small in this abrasive environment. The critical area appears to be the cutting edges of the comb and cutter [6, 8]. The influence of these edges on the process of shearing is described below.

The severing of wool by sheep shears can be modelled by considering the fibre to be acted upon by two indenters. Failure to sever the wool can be due to a number of criteria not being satisfied. For example, separation of cutter and comb perpendicular to the cutting plane may be sufficient to allow fibre bending at right angles and subsequent pulling of the wool between the comb and cutter [5, 9], Fig. 9. This separation arises from wear of the cutter and/or comb or from low forces on the tension rod.

The severing action of comb or cutter may be reduced due to edge damage such as rounding, gouging or chipping. This wear occurs from abrasive particles in the fleece such as silica (SiO_2) and pyrophyllite ($\text{AlSi}_2\text{O}_5(\text{OH})_4$). The mean particle size of these minerals was measured to be 70 μm and their hardnesses are about 750 H_v for SiO_2 and about 400 H_v for pyrophyllite. The cutter must travel a greater distance to effect severance if the comb edge is rounded (Fig. 10) and this, in turn, increases the work and power requirement of the shearing apparatus.

Another implication is that a large number of fibres could be caught between the cutter and comb which may cause clogging of the scissoring action.

4.3. Interaction of the cutter and groove in comb

The groove machined in the rear of the comb is intended to assist the clearing of debris when the comb is being ground. It may also play a role in removing wool debris (such as burrs, tangles and the like) from the shearing components during operation of the handpiece. Usually there is no interaction between the cutter surface and the groove when the comb is set against the rear of the comb bed. However, under normal set-up conditions the comb is not in this position and therefore the cutter follows a path that intersects with the groove in the comb as shown in Fig. 8. The cutter thus wears in localized regions so that the tips stand in relief. A surface scan of the cutters shows the similarity in wear patterns from both the laboratory and field tests (Fig. 5). This problem was exacerbated in these tests due to the high hardness of the TiN coating with respect to the steel of the cutter and the undressed state of the comb.

Thus the greater hardness of the TiN-coated surface enhanced wear of the cutter everywhere except over the groove which had not been removed by dressing. This resulted in a step in the cutter surface which reduced severing efficiency. It is believed that this life-limiting feature of the handpiece components would be negligible if the comb was appropriately dressed before coating with TiN. Another approach would be to modify the sliding face of the cutter.

5. Conclusion

The present study has not taken into consideration the influence of the tension adjustment on the shearing efficiency and components. A nominal value of 200 N was used. It is possible that a lower tension force is not detrimental to shearing efficiency and may enhance

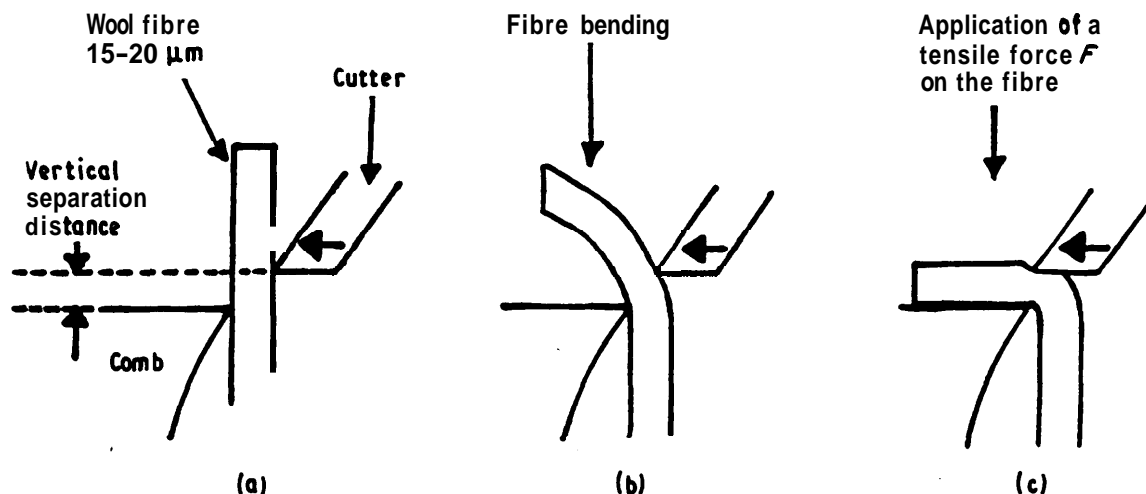

Figure 9 Incorrect adjustment of comb and cutter pair. (a) Vertical separation between comb and cutter. (b) Fibre bending as cutter advances. (c) Fibre bent at right angles between cutter and comb.

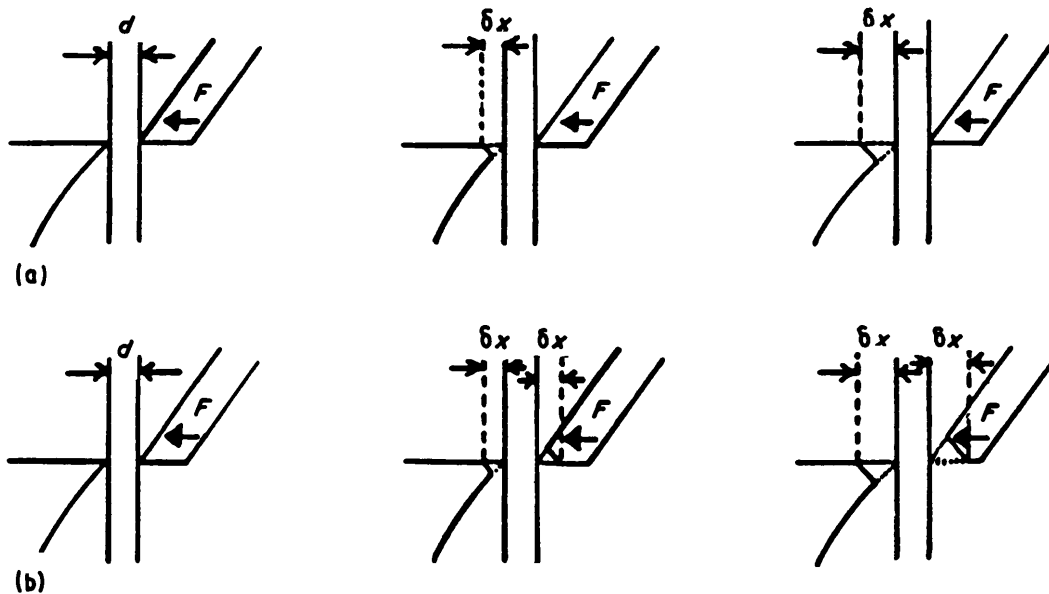

Figure 10 The effect of "edge rounding" on the severing mechanism of the comb and cutter. The mean diameter of the wool fibre is 20 μm and the degree of the rounding is 1–5 μm . (a) The influence of rounding the comb edge. (b) The effect of rounding the comb and cutter.

the life of other components in the shearing apparatus; for example the tension rod, rotating spindles and shafts, motor, etc. It is important to establish whether the initial setting of the tension is maintained for long shearing periods such as would be encountered with a robot shearer.

Damage to the cutting edges was the major contribution to reducing the cutting efficiency of the **cutter/comb** assembly. Therefore any means of protecting the edge from damage while retaining the optimum severing geometry should be investigated. The hard coatings that were studied alleviate this problem. Hard coatings also prevent fretting wear at the tips of the cutter.

These tests indicate that PVD coatings such as TiN, show great promise in reducing wear of sheep shearing components. The high density of TiN and the ability to form thin (4 μm) highly adherent coatings give advantages over other ceramic coatings – for example those produced by thermal spray processes, where porosity can be a serious problem. The thinner PVD coatings retain the optimum severing attributes compared with the thick (25 μm) WC–Co materials. The PVD coatings also allow greater control over surface finish, which was a major problem with the detonation gun process. The precise measurement of hardness for thin films is difficult [10] and it is estimated to lie between 1300 and 3000 VPN [11] for the TiN coatings used in the present work. A high hardness is normally correlated to an increased wear performance. Thicker TiN coatings, of about 14 μm , may produce a slight increase in hardness but this is not seen as an improvement in the sheep-shearing application because edge retention is the more essential criterion.

An advantage of the PVD technology is the lower processing temperature so that thermal distortion of the substrate is minimized. This was a major problem of some of the earlier work with the detonation gun

coatings [2]. The PVD process requires that the components are heated to approximately 500°C to achieve good adhesion to the substrate, whereas the manufacturing process of detonation-gun coatings has the potential of over heating the substrate. For example, measurements on combs with detonation-gun applied coatings exhibited softening of the steel to 45R_c. This indicates significant temperature excursions over the eutectoid temperature of the material. It should be noted that this decrease may not be overly detrimental to the comb's performance because it is the surface hardness of the material assembly that is crucial.

This work shows that PVD coatings can increase the efficiency of the shearing process. A secondary aspect of the work is that a test has been developed that is conceptually simple but has the advantage of being directly related to operational working conditions. This test reproduces the wear morphology of shearing components that have been used in the field.

Acknowledgements

We thank Mr A. P. White, Australian Wool Corporation, for arranging field trials and for his advice on comb and cutter preparation. Dr P. McNamara prepared the line drawings. The project was funded by the Australian Wool Corporation. Some of the coatings used in this work were manufactured by Darren Gansert under the direction of H. Herman of The Thermal Spray Laboratory, SUNY at Stony Brook (New York, USA).

References

1. D. R. SMITH and M. J. HINDLE, "Wool Harvesting Research and Development", edited by P. R. W. HUDSON (Australian Wool Corporation, Melbourne, 1980) pp. 141–61.
2. B. W. FIELD, in "MUSEVER Technical Memorandum MS-

- 56-83" (Department of Civil and Agricultural Engineering, Melbourne University, Melbourne, 1983) 4 p.
3. A. P. WHITE, "A guide for preparation of combs and cutters for shearing merino sheep", Automated Wool Shearing Group (University of Western Australia and The Australian Wool Corporation, Melbourne, 1987).
 4. C. M. PERROTT and J. P. MULLER, in "Proceedings of the Second National Conference on Wool Harvesting Research and Development", edited by P. R. W. Hudson (Austriian Wool Corporation, Sydney, 1981) pp. 297-304.
 5. R. A. DENNIS, *ibid.*, pp. 285-93.
 6. B. W. FIELD, in "Conference on Agricultural Engineering", 27-30 August 1984 (The Institute of Engineers, Australia, 1984) 4 p.
 7. Idem, "Conference on Agriculture Engineering", 11-14 November 1990 (The Institute of Engineers, Australia, 1990) pp. 5-9.
 8. K. R. ATKINSON and B. G. PARNELL, "Wool Harvesting Research and Development", edited by P. R. W. Hudson (Australian Wool Corporation, Melbourne, 1979) pp. 117-28.
 9. B. W. FIELD, A. J. MACKENZIE and M. I. AMERY, in "Wool Harvesting Research and Development", edited by P. R. W. Hudson (Australian Wool Corporation, Melbourne, 1980) pp. 267-83.
 10. P. J. BURNETT and D. S. RICKERBY, *Surface Engng* 3 (1987) 69.
 11. S. J. BULL and D. S. RICKERBY, *Surface Coatings Technol.* 42 (1990) 149.

*Received 2 September 1991
and accepted 7 May 1992*